

LOWER
SCALE: 1/4" = 1'-0"

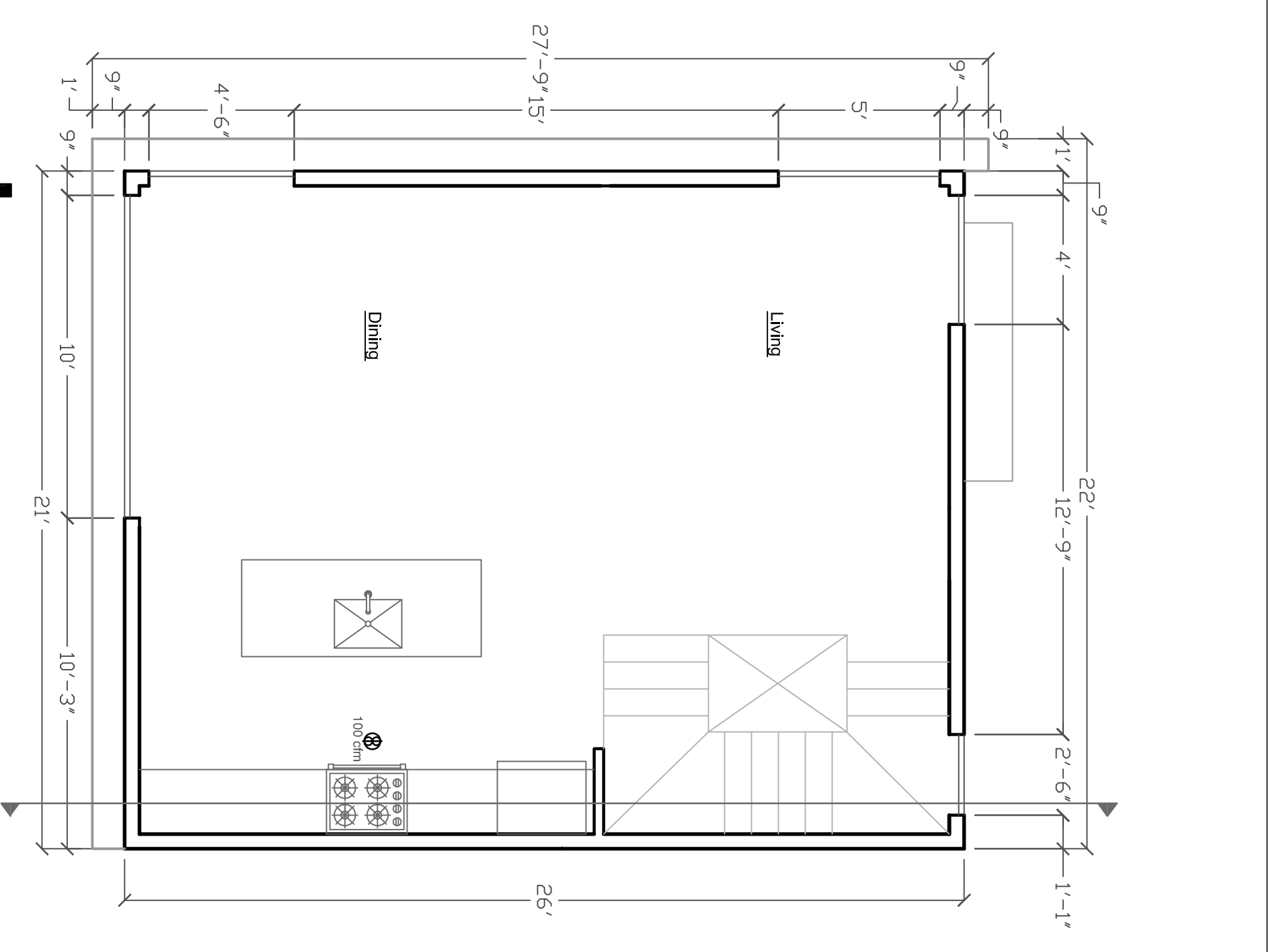

MAIN
SCALE: 1/4" = 1'-0"

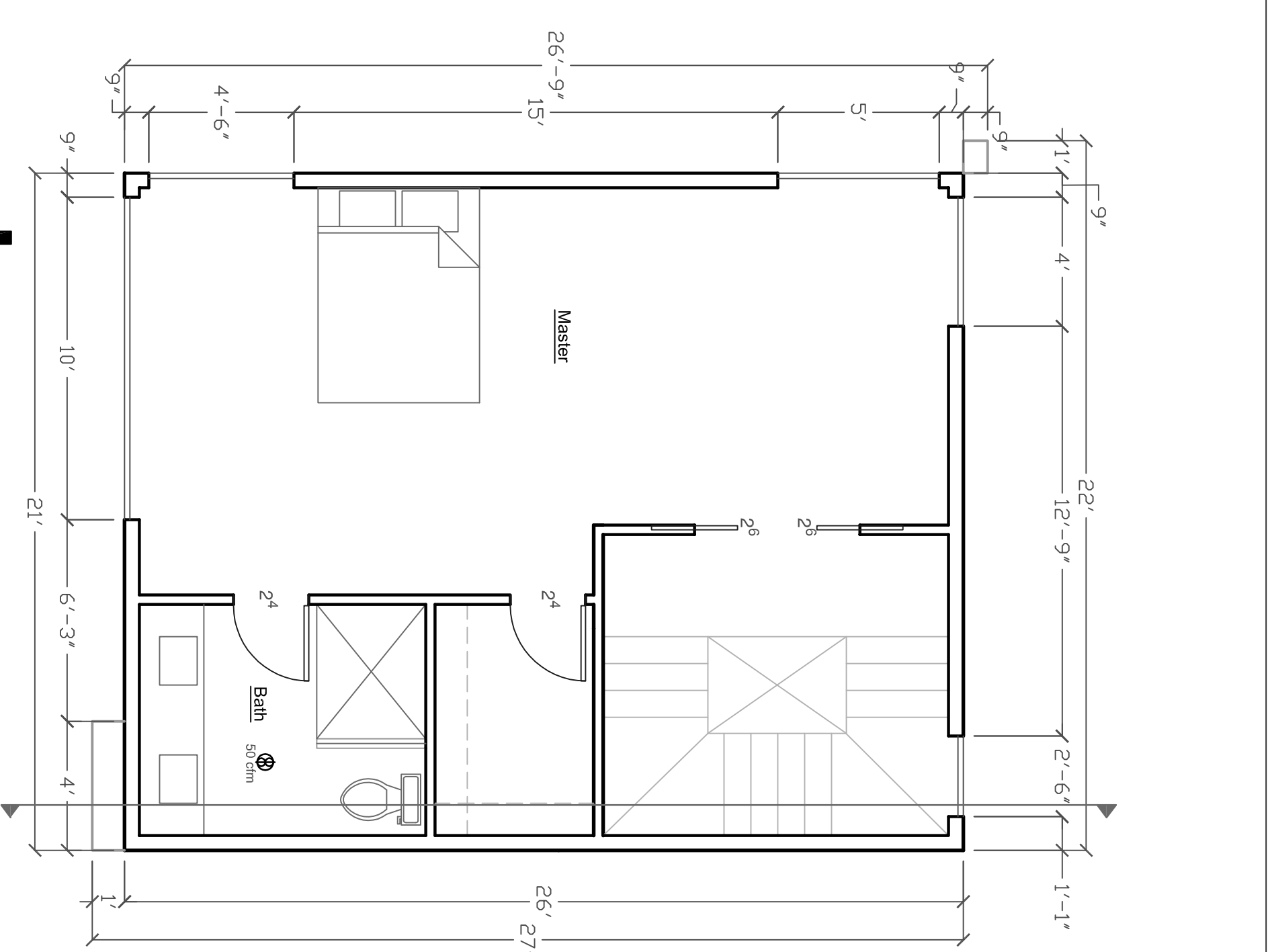

UPPER
SCALE: 1/4" = 1'-0"

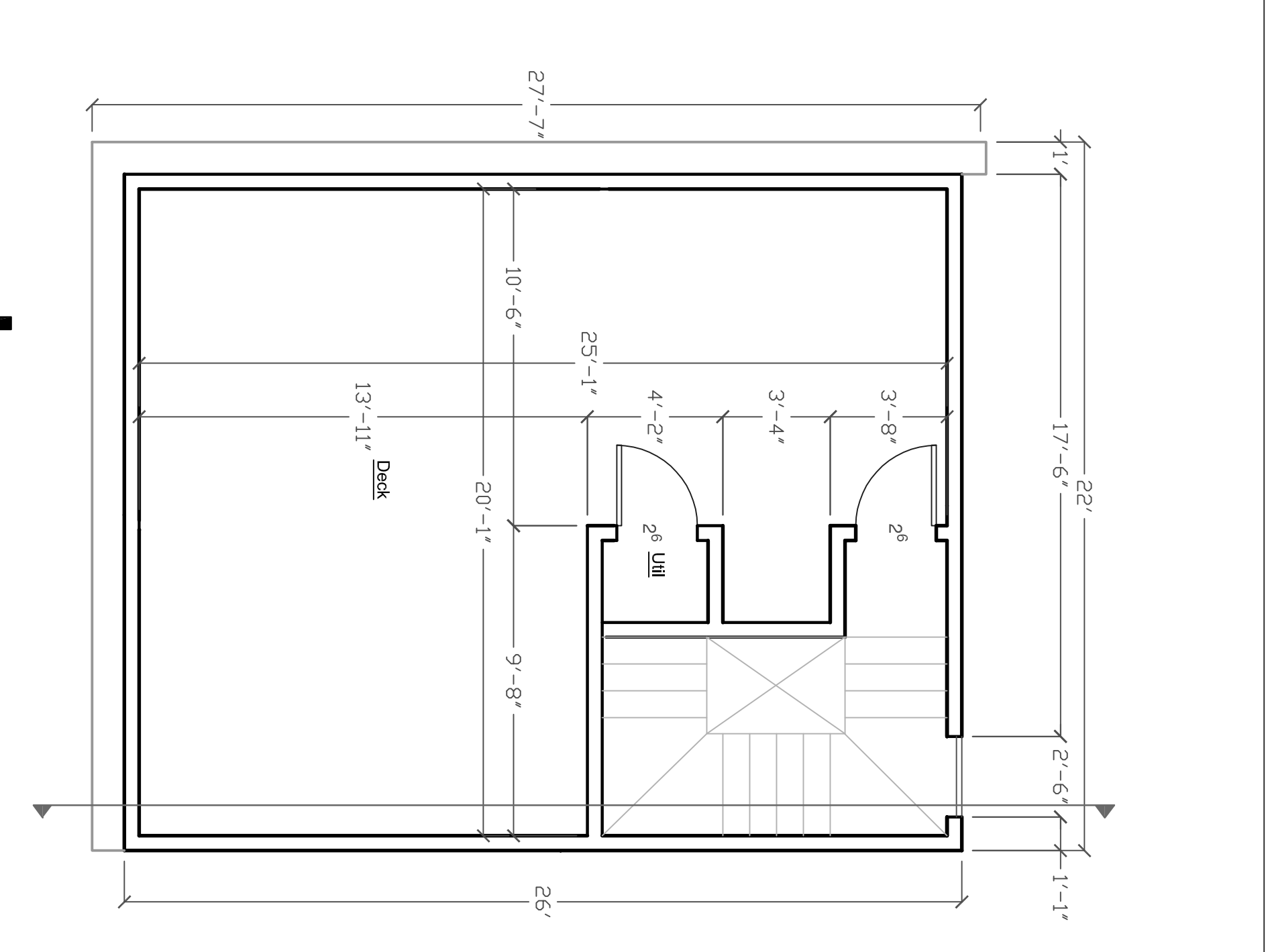

ROOF
SCALE: 1/4" = 1'-0"

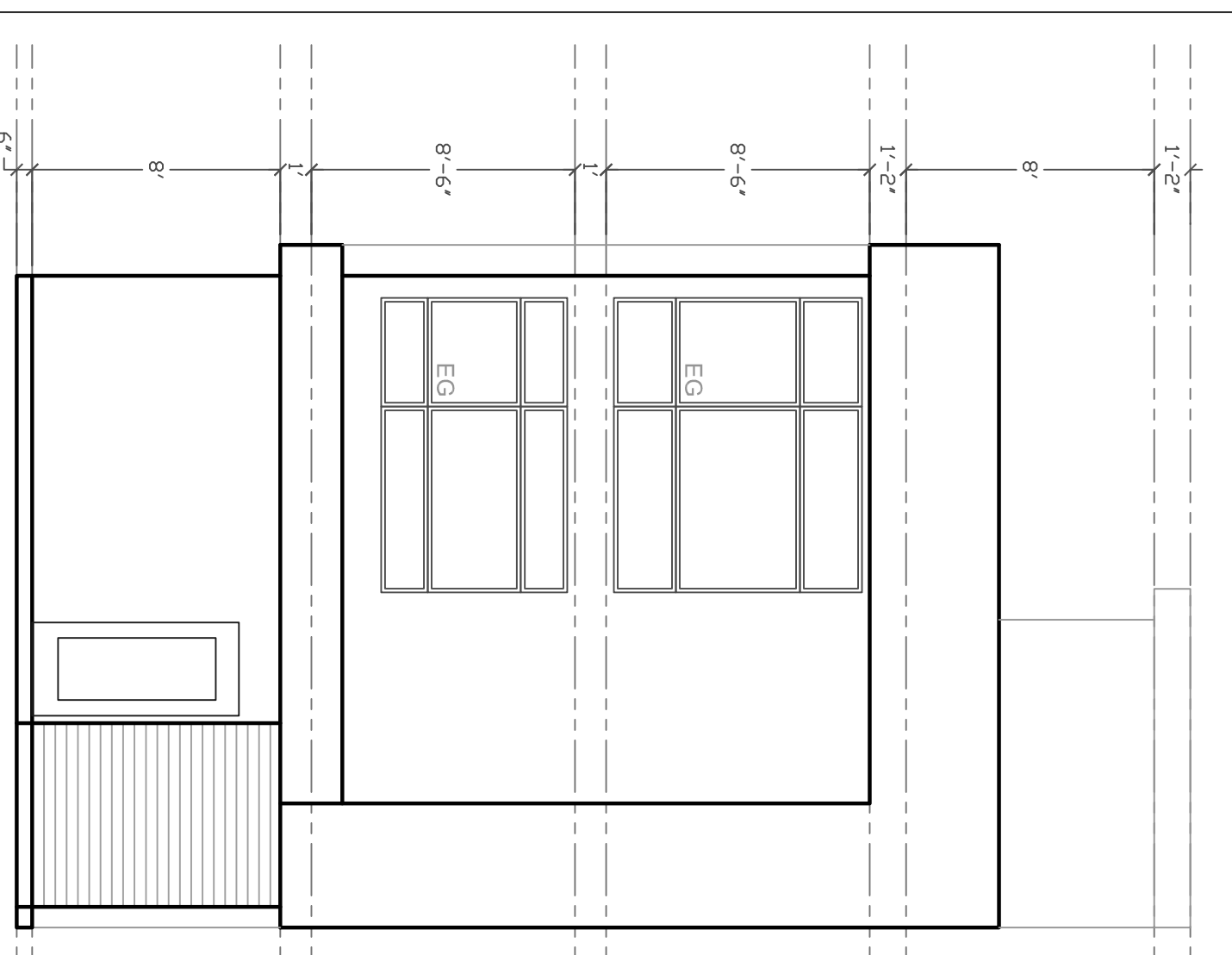

SOUTH
SCALE: 3/16" = 1'-0"

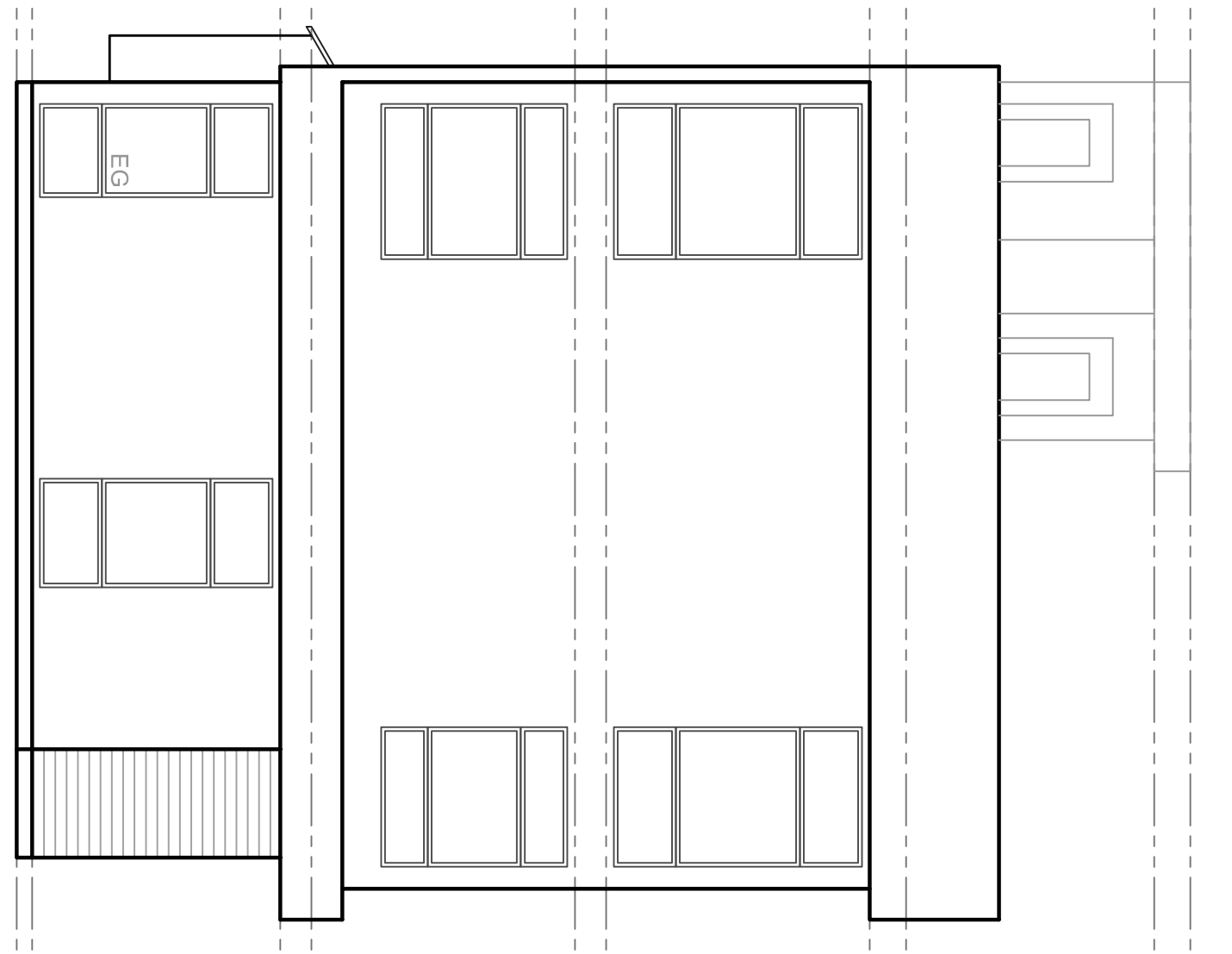

WEST
SCALE: 3/16" = 1'-0"

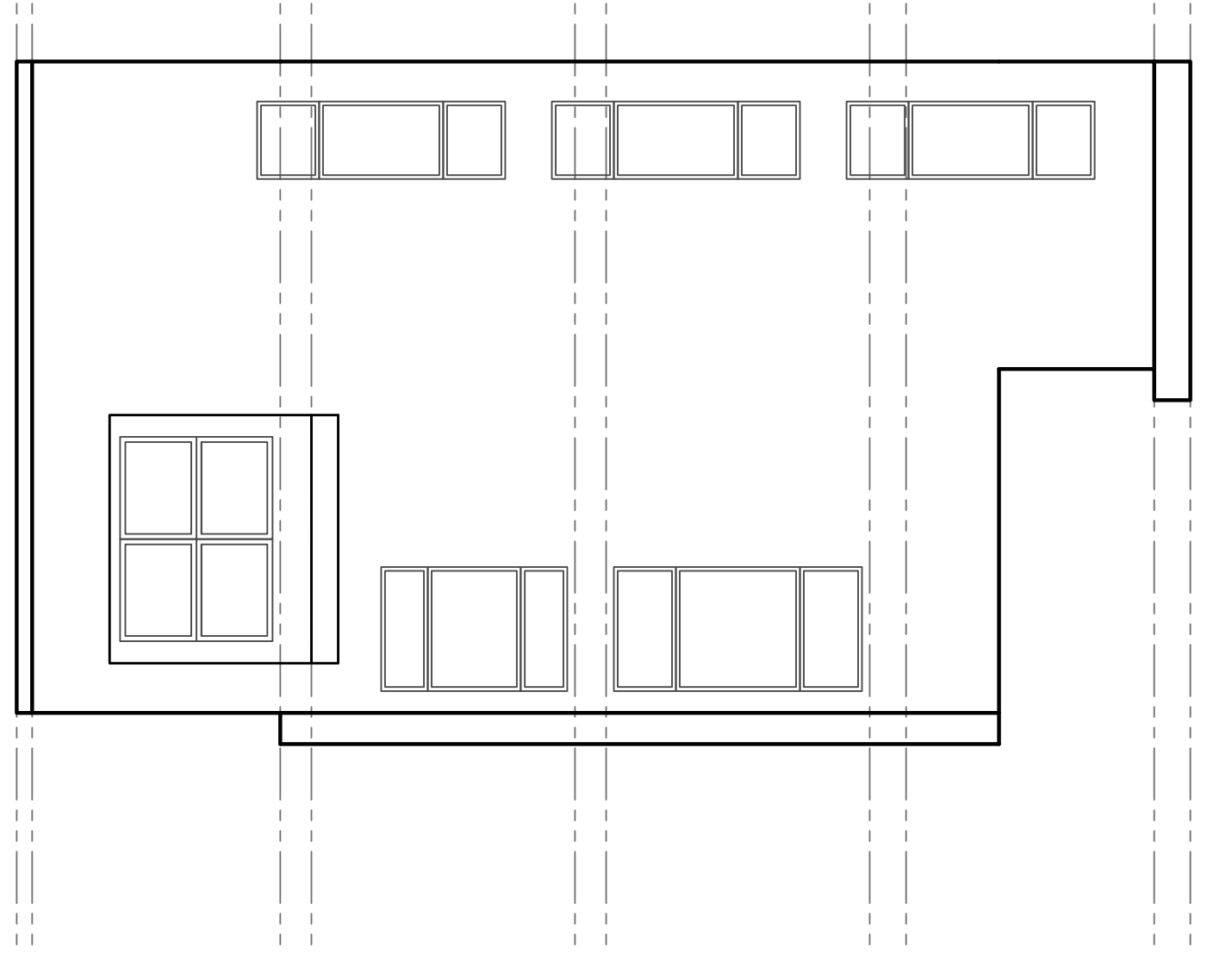

NORTH
SCALE: 3/16" = 1'-0"

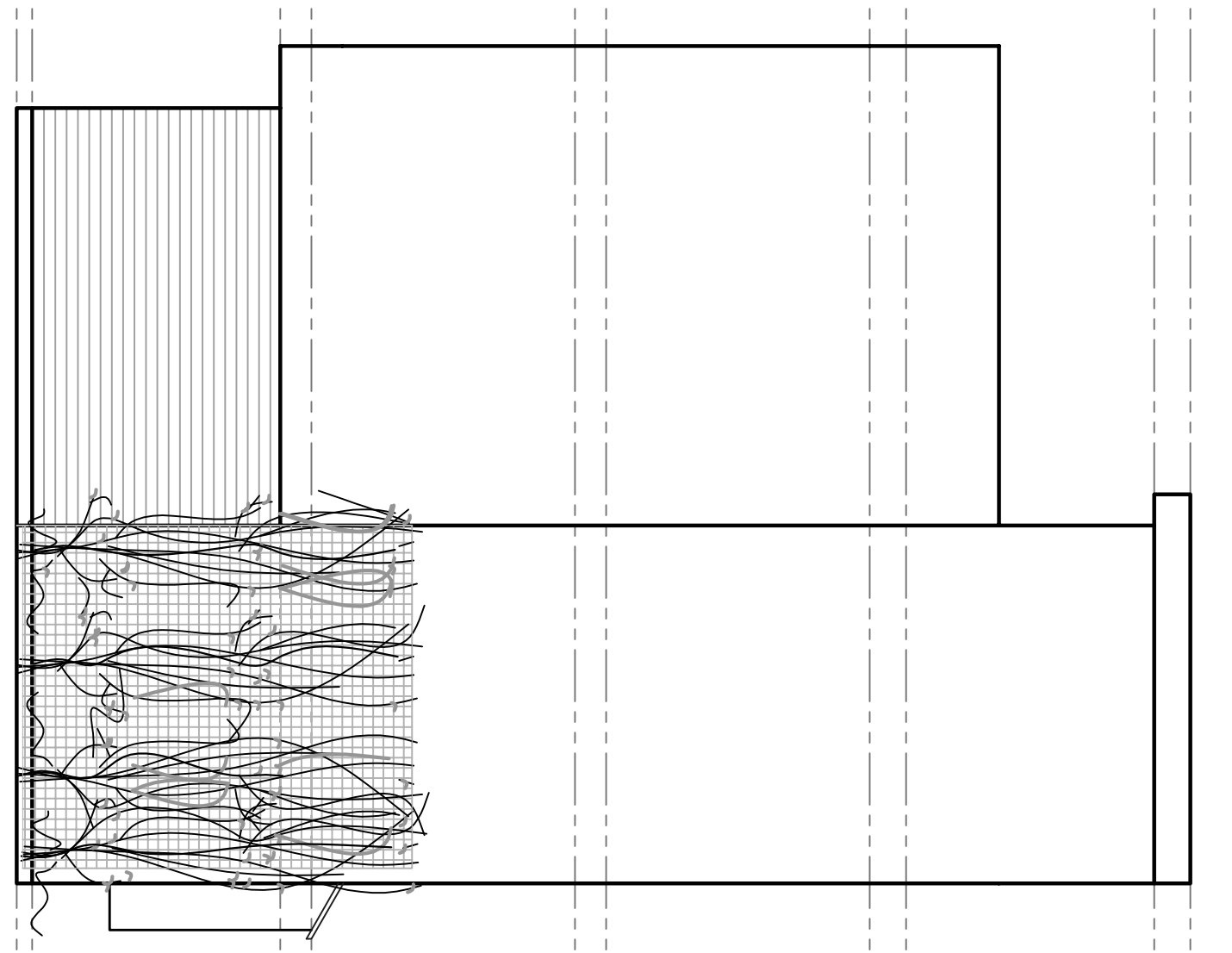

EAST
SCALE: 3/16" = 1'-0"

build urban

PROJECT:
2347 Minor Ave E.

LOCATION:
Seattle, WA